



Technical Specifications *

Accuracy:	< 2% of FS range under constant conditions
Analysis:	0-1%, 0-5%, 0-10%, 0-25% FS ranges; auto-ranging or fixed single range
Application:	Oxygen analysis in inert, hydrocarbon, helium, hydrogen, mixed and acid (CO ₂) gas streams
Approvals:	Certified for use in hazardous areas - see lower right
Area Classification:	Class I, Division 1, Group C, D hazardous areas with external intrinsic safety barrier
Calibration:	Max interval—3 months. Air calibrate with clean source of certified span gas, compressed, or ambient (20.9% O ₂) air on 0-25% range.
Compensation:	Temperature
Connections:	1/8" compression tube fittings
Controls:	Water resistant keypad; menu driven range selection, calibration and system functions
Display:	Graphical LCD 2.75" x 1.375"; resolution 0.001%; displays real time ambient temperature and pressure
Enclosure:	Painted aluminum 4 x 9 x 3", 8 lbs.
Flow Sensitivity:	None between 0.5-5 SCFH, 1-2 SCFH recommended
Linearity:	±1% of full scale
Pressure:	Inlet - regulate to 5-30 psig to deliver 1-2 SCFH flow; vent - atmospheric
Power:	18-24 VDC
Response Time:	90% of final reading in 13 seconds
Sample System:	None
Sensitivity:	< 0.5% of FS range
Sensor Model:	GPR-11-32-RTS for non-acid (CO ₂) gas streams; XLT-11-24-RTS for gases containing > 0.5% CO ₂
Sensor Life:	GPR-11-32-RTS 32 months in air at 25°C and 1 atm XLT-11-24-RTS 24 months in air at 25°C and 1 atm
Signal Output:	4-20mA non-isolated
Operating Range:	5°C to 45°C (GPR sensor), -10° to 45°C (XLT sensor)
Warranty:	12 months analyzer; 12 months sensor
Wetted Parts:	Stainless steel

ATEX Certified for Hazardous Areas



GPR-2500 ATEX Oxygen Transmitter

**Intrinsic Safety Barrier MTL7706+ or Equivalent
2 Wire Loop Powered O₂ Transmitter**

**Advanced Galvanic Sensor Technology with
Optional Sample Systems**

**ATEX Certified - Directive 94/9/EC
Examination Cert: INERIS 08ATEX0036**



**II 2 G
Ex ia IIB T4
T_{amb} -20°C to +50°C**



0080

Optional Equipment

Sample conditioning system - Contact factory.

* Subject to change without notice

**ISO 9001:2008 Certified
INTERTEK Certificate No. 485**



GPR-2500

% Oxygen Transmitter



Owner's Manual

Revised July 2013

Revised April 2014

Table of Contents

Introduction		1
Quality Control Certification		2
Safety		3
Features & Specifications		4
Operation		5
Maintenance		6
Spare Parts		7
Troubleshooting		8
Warranty		9
Material Safety Data Sheets		10
Drawings		A/R
Explosion Proofing Electrical Connections	Appendix	A
Correlating readings – LCD display to 4-20mA signal output	Appendix	B
H2S Scrubber, Sample System, Media MSDS	Appendix	F
Maintenance H2S Scrubber & Coalescing Filter	Appendix	G

The appendices referenced above are an integral part of the documentation, installation and maintenance of this analyzer to comply with all applicable directives. It is important that users review these documents before proceeding.

1. Introduction

Your new oxygen transmitter incorporates an advanced electrochemical sensor specific to oxygen along with state-of-the-art digital electronics designed to give you years of reliable precise oxygen measurements in a variety of industrial oxygen applications. More importantly, it has been constructed as intrinsically safe in accordance with ATEX Directives 94/9/CE for use in hazardous areas in zone 1 Group C and D.

Analytical Industries, Inc.
dba Advanced Instruments Inc.
2855 Metropolitan Place, Pomona, CA 91767 USA

GPR-1500/2500

CE 0080

Serial No.:

Year of Manufacture:
INERIS 08ATEX0036



II 2 G

Ex ia IIB T4 Gb

T_{amb} -20°C to +50°C



WARNING: POTENTIAL ELECTROSTATIC CHARGING HAZARD – SEE INSTRUCTIONS

The design also meets NEC intrinsic safety standards for use in Class 1, Division 1, Group C, D hazardous areas. Please refer to Appendix A for information on making electrical connections that maintain the desired level of protection.

To obtain maximum performance from your new oxygen transmitter, please read and follow the guidelines provided in this Owner's Manual.

Every effort has been made to select the most reliable state of the art materials and components, to design the transmitter for superior performance and minimal cost of ownership. This transmitter was tested thoroughly by the manufacturer prior to shipment for best performance.

However, modern electronic devices do require service from time to time. The warranty included herein plus a staff of trained professional technicians to quickly service your transmitter is your assurance that we stand behind every transmitter sold.

The serial number of this transmitter may be found on the inside the transmitter enclosure. You should note the serial number in the space provided and retains this Owner's Manual as a permanent record of your purchase, for future reference and for warranty considerations.

Serial Number: _____

Advanced Instruments Inc. appreciates your business and pledges to make every effort to maintain the highest possible quality standards with respect to product design, manufacturing and service.

3. General Safety & Installation

This section summarizes the essential precautions applicable to the GPR-1500/2500 Oxygen Transmitter. Additional precautions specific to individual transmitter are contained in the following sections of this manual. To operate the transmitter safely and obtain maximum performance follow the basic guidelines outlined in this Owner's Manual.



Caution: This symbol is used throughout the Owner's Manual to Caution and alert the user to recommended safety and/or operating guidelines.



Warning: This symbol is used throughout the Owner's Manual to Warn and alert the user of the presence of electrostatic discharge.



Danger: This symbol is used throughout the Owner's Manual to identify sources of immediate Danger such as the presence of hazardous voltages.

Read Instructions: Before operating the transmitter read the instructions.

Retain Instructions: The safety precautions and operating instructions found in the Owner's Manual should be retained for future reference.

Heed Warnings: Follow all warnings on the transmitter, accessories (if any) and in this Owner's Manual.

Follow Instructions: Observe all precautions and operating instructions. Failure to do so may result in personal injury or damage to the transmitter.

Analyzer label

Maintenance

Serviceability: Except for replacing the oxygen sensor, there are no parts inside the transmitter for the operator to service.

Only trained personnel with the authorization of their supervisor should conduct maintenance.

Oxygen Sensor: DO NOT open the sensor. The sensor contains a corrosive liquid electrolyte that could be harmful if touched or ingested, refer to the Material Safety Data Sheet contained in the Owner's Manual appendix. Avoid contact with any liquid or crystal type powder in or around the sensor or sensor housing, as either could be a form of electrolyte. Leaking sensors should be disposed of in accordance with local regulations.

Troubleshooting: Consult the guidelines in Section 8 for advice on the common operating errors before concluding that your transmitter is faulty. Do not attempt to service the transmitter beyond those means described in this Owner's Manual.

Do not attempt to make repairs by yourself as this will void the warranty as per Section 10 and may result in electrical shock, injury or damage. All other servicing should be referred to qualified service personnel.

Cleaning: The transmitter should be cleaned only as recommended by the manufacturer. Wipe off dust and dirt from the outside of the unit with a soft damp cloth then dry immediately. Do not use solvents or chemicals.

Nonuse Periods: If the transmitter is equipped with a POWER switch advance the switch to the OFF position and disconnect the power when the transmitter is left unused for a long period of time.

Installation

This analyzer has been constructed in compliance with

EN 60079-0 : 2007
EN 60079-11 : 2012

It must be installed in accordance with

EN 60079-14

Gas Sample Stream: Ensure the gas stream composition of the application is consistent with the specifications and if in doubt, review the application and consult the factory before initiating the installation. **Note:** In natural gas applications such as extraction and transmission, a low voltage current is applied to the pipeline itself to inhibit corrosion of the pipeline. As a result, electronic devices connected to the pipeline can be affected unless they are adequately grounded.

Contaminant Gases: A gas scrubber and flow indicator with integral metering valve are required upstream of the analyzer to remove any interfering gases such as oxides of sulfur and nitrogen or hydrogen sulfide that can interfere with measurement and cause reduction in the expected life of the sensor. Consult the factory for recommendations concerning the proper selection and installation of components.

Expected Sensor Life: With reference to the publish specification located at the last page of this manual, the expected life of all oxygen sensors is predicated on oxygen concentration in ambient air, temperature (77°F/25°C) and pressure (1 atmosphere) in "normal" applications. Deviations from standard conditions will affect the life of the sensor. As a rule of thumb sensor life is inversely proportional to changes in the pressure and temperature.

Accuracy & Calibration: Refer to section 5 Operation.

Operating Temperature: The sample must be sufficiently cooled before it enters the analyzer and any optional components. A coiled 10 foot length of ¼" stainless steel tubing is sufficient for cooling sample gases as high as 1,800 °F to ambient. The recommended operating temperature is below 35 °C. However, the analyzer may be operated at temperature up to 45 °C on an intermittent basis but the user is expected to accept a reduction in expected sensor life – as a rule of thumb, for every degree °C increase in temperature (above 25 °C), the sensor life is reduced by approximately 2.5%.



Heat: Situate and store the analyzer away from direct sources of heat.

Liquid and Object Entry: The analyzer should not be immersed in any liquid. Care should be taken so that liquids are not spilled into and objects do not fall into the inside of the analyzer.

Handling: Do not use force when using the switches, knobs or other mechanical components. Before moving your analyzer be sure to disconnect the wiring/power cord and any cables connected to the output terminals of the analyzer.

Sample Pressure and Flow

All electrochemical oxygen sensors respond to partial pressure changes in oxygen. The sensors are equally capable of analyzing the oxygen content of a flowing sample gas stream or monitoring the oxygen concentration in ambient air (such as a confined space in a control room or an open area around a landfill or bio-pond). The following is applicable to analyzers equipped with fuel cell type oxygen sensors.

Analyzers designed for in-situ ambient or area monitoring has no real sample inlet and vent. The sensor is exposed directly to the sample gas and it is intended to operate at atmospheric pressure. The analyzer has a built-in pressure sensor and the sensor output is automatically compensated for any atmospheric pressure changes.

Inlet Pressure: For the analyzers designed to measure oxygen in a flowing gas stream, the inlet sample pressure must be regulated between 5-30 psig. Although the rating of the SS tubing and tube fittings/valves itself is considerably higher (more than 100 psig), a sample pressure of 5-30 psig is recommended for ease of control of sample flow. The analyzer equipped with a sample system has designated SAMPLE and VENT ports. Connect SAMPLE gas to SAMPLE and the vent to the VENT ports only.



Caution: If the analyzer is equipped with an optional H₂S scrubber, sample inlet pressure must not exceed 30 psig.

Outlet Pressure: In applications where sample pressure is positive, the sample must be vented to an exhaust pipe at a pressure less than the inlet pressure so that the sample gas can flow through the sensor housing. Ideally, the sample must be vented to atmospheric pressure.

Note: The sensor may be used at a slight positive pressure (e.g., when sample is vented to a common exhaust where the pressure might be higher than 1 atmosphere). However, the pressure at the sensor must be maintained at all times including during the span calibration. This may be accomplished by using a back-pressure regulator at vent line of the analyzer. **Caution:** A sudden change in pressure at the sensor may result in the sensor electrolyte leakage.

Flow rates of 1-2 SCFH cause no appreciable change in the oxygen reading. However, flow rates above 5 SCFH may generate a slight backpressure on the sensor resulting in erroneous oxygen readings.



Caution: Do not place your finger over the vent (it pressurizes the sensor) to test the flow indicator when gas is flowing to the sensor. Removing your finger (the restriction) generates a vacuum on the sensor and may damage the sensor (voiding the sensor warranty).

Application Pressure - Positive: A flow indicator with integral metering valve positioned upstream of the sensor is recommended for controlling the sample flow rate between 1-5 SCFH. If a separate flow control valve and a flow indicator is used, position flow control valve upstream of the sensor and position a flow indicator downstream of the sensor. If necessary, a pressure regulator upstream of the flow control valve should be used to regulate the inlet pressure between 5-30 psig.

Caution: If the analyzer is equipped with a H₂S scrubber as part of an optional sample conditioning system, inlet pressure must not exceed 30 psig.

Application Pressure - Atmospheric or Slightly Negative: For % oxygen measurements, an optional external sample pump may be used upstream of the sensor to push the sample across the sensor and out to atmosphere. For PPM oxygen measurements, an optional external sampling pump should be positioned downstream of the sensor to draw the sample from the process, by the sensor and out to atmosphere. A flow meter is generally not necessary to obtain the recommended flow rate with most sampling pumps. However, if the sample pump can pull/push more than 5 SCFH, a flow control must be used to control the sample flow. The flow control valve must be positioned in such a way that it does not generate any vacuum on the sensor.



Caution: If the analyzer is equipped with a flow indicator with integral metering valve or a metering flow control valve upstream of the sensor and the pump is installed downstream of sensor- open the metering valve completely before turning the pump ON to avoid drawing a vacuum on the sensor and placing an undue burden on the pump.

If pump loading is a consideration, a second throttle valve on the pump's inlet side may be necessary to provide a bypass path so the sample flow rate is within the above parameters.

Moisture & Particulates: Installation of a suitable coalescing or particulate filter is required to remove condensation, moisture and/or particulates from the sample gas to prevent erroneous analysis readings and damage to the sensor or other optional components. Moisture and/or particulates do not necessarily damage the sensor. However, collection of moisture/particulate on the sensing surface can block or inhibit the diffusion of sample gas into the sensor resulting in a reduction of sensor signal output – and the appearance of a sensor failure. Consult the factory for recommendations concerning the proper selection and installation of optional components.

Moisture and/or particulates generally can be removed from the sensor by opening the sensor housing and either blowing on the sensing surface or gently wiping or brushing the sensing surface with damp cloth. **Caution:** Minimize the exposure of PPM sensors to air during this cleaning process. Air calibration followed by purging with zero or a gas with a low PPM oxygen concentration is recommended after the cleaning process is completed.

Mounting: The analyzer is approved for indoor as well as outdoor use. However, avoid mounting in an area where direct sun might heat up the analyzer beyond the recommended operating temperature range. If possible, install a small hood over the analyzer for rain water drain and to prevent over-heating of analyzer..

Gas Connections: The Inlet and outlet vent gas lines require 1/8" or 1/4" stainless steel compression type tube fittings. The sample inlet tubing must be metallic, preferably SS. The sample vent line may be of SS or hard plastic tubing with low gas permeability.

Power: Supply power to the analyzer only as rated by the specification or markings on the analyzer enclosure. The GPR-2500 is a two wire loop powered analyzer. To comply with the ATEX Directives 94/9/CE, power to the transmitter must be provided via an approved intrinsic safety barrier MTL 7706+ or equivalent.

WARNING: TRANSMITTER RATING FOR USE IN HAZARDOUS AREA WILL VOID WITHOUT THE USE OF INTRINSIC SAFETY BARRIER

The input power must be between 24-28 VDC. The wiring that connects the analyzer to the power source should be installed in accordance with recognized electrical standards. Ensure that the analyzer case is properly grounded and meets the requirements for area classification where the analyzer is installed. Never yank wiring to remove it from a terminal connection.

The two wire loop powered analyzers consume no more than **0.68 Watts** of power.

4. Features & Specifications



Advanced Instruments Inc.

Technical Specifications

Accuracy:	2% of FS range under constant conditions
Analysis:	0-1%, 0-5%, 0-10%, 0-25% FS ranges; auto-ranging or manually lock on single range
Application:	Oxygen analysis in inert, hydrocarbon, helium, hydrogen, mixed and acid (CO ₂) gas streams
Approvals:	CE TYPE EXAMINATION CERTIFICATE: INERIS 08ATEX0036  II 1 G Ex Ia IIB T4 Gb T _{amb} -20°C to +50°C
Area Classification:	Meets recognized intrinsic safety standards for use in Class 1, Division 1, Group C-D hazardous areas
Calibration:	Certified gas of O ₂ balance N ₂ approximating 80% of range above analysis range recommended for optimum results
Compensation:	Barometric pressure and temperature
Connections:	1/8" compression tube fittings
Controls:	Water resistant keypad; menu driven range selection, calibration and system functions
Display:	Graphical LCD 2.75" x 1.375"; resolution .001%; displays real time ambient temperature and pressure
Enclosure:	Painted aluminum NEMA 4X, 4"x9"x3", 8 lbs.
Flow Sensitivity:	None between 0.5-5 SCFH, 1-2 SCFH recommended
Linearity:	> .995 over all ranges
Pressure:	Inlet - regulate to 5-30 psig; vent - atmospheric
Power:	18-28 VDC two wire loop power; minimum 24 VDC with optional intrinsic safety barriers
Response Time:	90% of final FS reading in 10 seconds
Sample System:	None - designate either connection as inlet or vent
Sensitivity:	< 0.5% of FS range
Sensor Model:	GPR-11-32-4
Sensor Life:	36 months in air at 25°C and 1 atm
Signal Output:	4-20mA
Operating Range:	Recommended -10° to 45°C (GPR sensor), -20° to 45°C (XLT sensor)
Warranty:	12 months analyzer; 12 months sensor
Wetted Parts:	Corrosion resistant material

Optional Equipment

XLT-11-24-4 sensor for gases with > 0.5% CO₂ present (24 month life as above)
 Sample flow control panel



GPR-2500

2 Wire Loop Powered O₂ Transmitter

Advanced Sensor Technology
 Accuracy < 1% FS Range
 Sensitivity < 0.5% FS Range

Intrinsically Safe with safety Barrier
 MTL7706+ OR EQUIVALENT

CE



ISO 9001:2000 QA System
 Certificate No. 485

5. Operation

Principle of Operation

The GPR-2500 Oxygen Transmitter incorporates a variety of advanced galvanic fuel cell type oxygen sensors. These sensors are very specific to oxygen and generate an electrical signal proportional to the amount of oxygen present in a gas stream. The selection of a particular type of sensor depends on the composition of the sample gas stream. Consult the factory for recommendation.

The signal processing electronics and sensor are housed in a general purpose NEMA 4X rated enclosure. The terminals for incoming power, signal output and intrinsic safety barriers are mounted on a PCB housed in an explosion proof enclosure.

The intrinsic safety barriers MTL7706+ or equivalent, limits the amount of power that flows to and from the signal processing electronics to a safe level effectively preventing an explosive condition. The analyzer design conforms to the ATEX Directive 94/9/CE for equipment as intrinsically safe and has been approved by an independent body: EC Type Examination Certificate: INERIS 08ATEX0036
The analyzer carries the following area classification



II 2 G,
Ex ia IIB T4 Gb
T_{amb} -20°C to +50°C



WARNING: POTENTIAL ELECTROSTATIC CHARGING HAZARD-SEE INSTRUCTION

The GPR-2500 also meets the intrinsic safety standards required for use in Class 1, Division 1, Group C, D hazardous areas.

Advanced Galvanic Sensor Technology

All galvanic type sensors function on the same principle and are specific to oxygen. They measure the partial pressure of oxygen from low PPM to 100% levels in inert gases, gaseous hydrocarbons, helium, hydrogen and mixed gases

Design Objectives

- Improve quality and reliability through a proprietary controlled manufacturing process . . .
- Comply with domestic and international quality standards
- Compact disposable dimensions
- No sensor maintenance
- Improve performance over replacement sensors - sensitivity, stability, response, recovery
- Longer operating and shelf life - translate into longer warranty period
- Low cost of ownership

% Oxygen Sensors

- Extend operating life to 10 years in air (20.9% O₂) . . .
24 months in continuous 100% O₂
- Extended operating range to -40° C/F to 50° C
- Excellent stability at elevated pressure . . .
Up to 10 atmospheres in hyperbaric chambers
- Superior compatibility with 0.5 - 100% CO₂ gas streams
24 month operating life in traditional dimensions
- Develop special sensor for fast response and long life
Large cathode with proprietary electrolytes and anodes

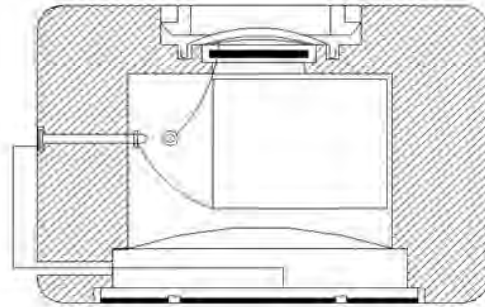

GPR/XLT 11 Series % Oxygen Sensor

Oxygen, the fuel for this electrochemical transducer, diffusing into the sensor, reacts electrochemically at the sensing electrode to produce an electrical current output proportional to the oxygen concentration in the gas phase. The sensor's signal output is linear over all measuring ranges and remains virtually constant over its useful life. The sensor requires no maintenance and is easily and safely replaced at the end of its useful life.

Proprietary advancements in design and chemistry add significant advantages to this extremely versatile oxygen sensing technology. Sensors for low % analysis recover from air to low % levels in seconds, exhibit longer life and reliable quality. The expected life of our new generation of percentage range sensors now range from 32 months to ten years with faster response times and greater stability. Another significant development involves expanding the operating temperature range for percentage range sensors from -20°C to 50°C. Contact factory for more specific information about your application.

Electronics

The signal generated by the sensor is processed by state of the art low power micro-processor based digital circuitry. The first stage amplifies the signal. The second stage eliminates the low frequency noise. The third stage employs a high frequency filter and compensates for signal output variations caused by ambient temperature changes. The result is a very stable signal. Sample oxygen is analyzed very accurately. Response time of 90% of full scale is less than 10 seconds (actual experience may vary due to the integrity of sample line connections, dead volume and flow rate selected) on all ranges under ambient monitoring conditions. Sensitivity is typically 0.5% of full scale of the low range. Oxygen readings may be recorded by an external device via the 4-20 mA or 1-5V signal output.

Sample System:

The standard GPR-2500 is supplied without a sample conditioning system thereby giving users the option of adding their own or purchasing a factory designed sample conditioning system, see section 2 QC Certification for optional equipment ordered. Whatever the choice, the sample must be properly conditioned before introducing it to the sensor to ensure an accurate measurement.

The GPR-2500 is generally supplied with a minimum of a sample flow control valve and a flow meter. Users interested in adding their own sample conditioning system should consult the factory. Advanced Instruments Inc. offers a full range of sample handling, conditioning and expertise to meet your application requirements. Contact us at 909-392-6900 or e-mail us at info@aii1.com.

Calibration & Accuracy Overview

Single Point Calibration: As previously described the galvanic type oxygen sensor generates an electrical current proportional to oxygen concentration in the sample gas. In the absence of oxygen the sensor exhibits an absolute zero, e.g. the sensor does not generate a current output in the absence of oxygen. Given these linearity and absolute zero properties, single point calibration is possible.

Pressure: Because sensors are sensitive to partial pressure of oxygen in the sample gas, output is a function of the number of molecules oxygen or percentage 'per unit volume'.

Temperature: The rate at which oxygen molecules diffuse into the sensor is controlled by a Teflon membrane otherwise known as an 'oxygen diffusion limiting barrier' and all diffusion processes are temperature sensitive, the fact the sensor's electrical output will vary with temperature is normal. This variation is relatively constant (2.5% per °C). A temperature compensation circuit employing a thermistor and a network of resistors offsets this effect with an accuracy of $\pm 5\%$ or better over a wide operating temperature range e.g., 5-45 °C can be obtained thus the signal output remains virtually independent of ambient temperature. There is extremely low error in measurement if the calibration and sampling are performed at similar temperatures (within ± 5 °C. Conversely, a temperature variation of 10 °C may produce an error of $>2\%$ of full scale.

Accuracy: In light of the above parameters, the overall accuracy of an analyzer is affected by two types of errors: 1) 'percent of reading errors', illustrated by Graph A below and 2) 'percent of full scale errors', illustrated by Graph B, such as 1-2% errors in readout and calibration devices. Other errors are 'spanned out' during calibration, especially when analyzer is calibrated close to the top end of the measuring range.

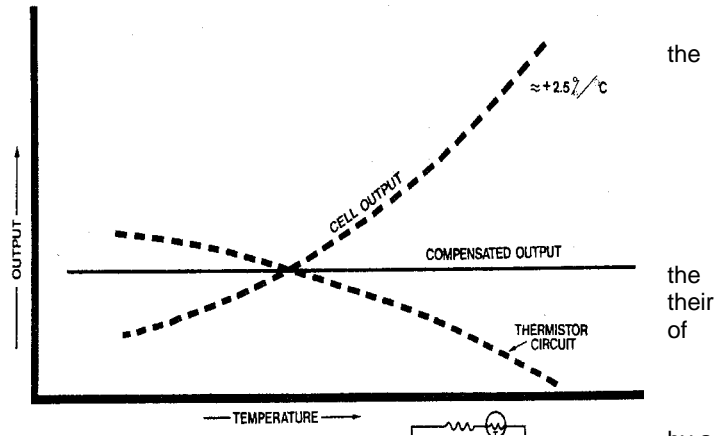

Mounting the Transmitter

The GPR-2500 analyzer consists of two interconnected enclosures (without the optional sample conditioning system and panel) and measures 8"H x 15-3/4"W x 7"D. This configuration is designed to be mounted directly to any flat vertical surface, wall or bulkhead plate by using four (4) appropriate screws.

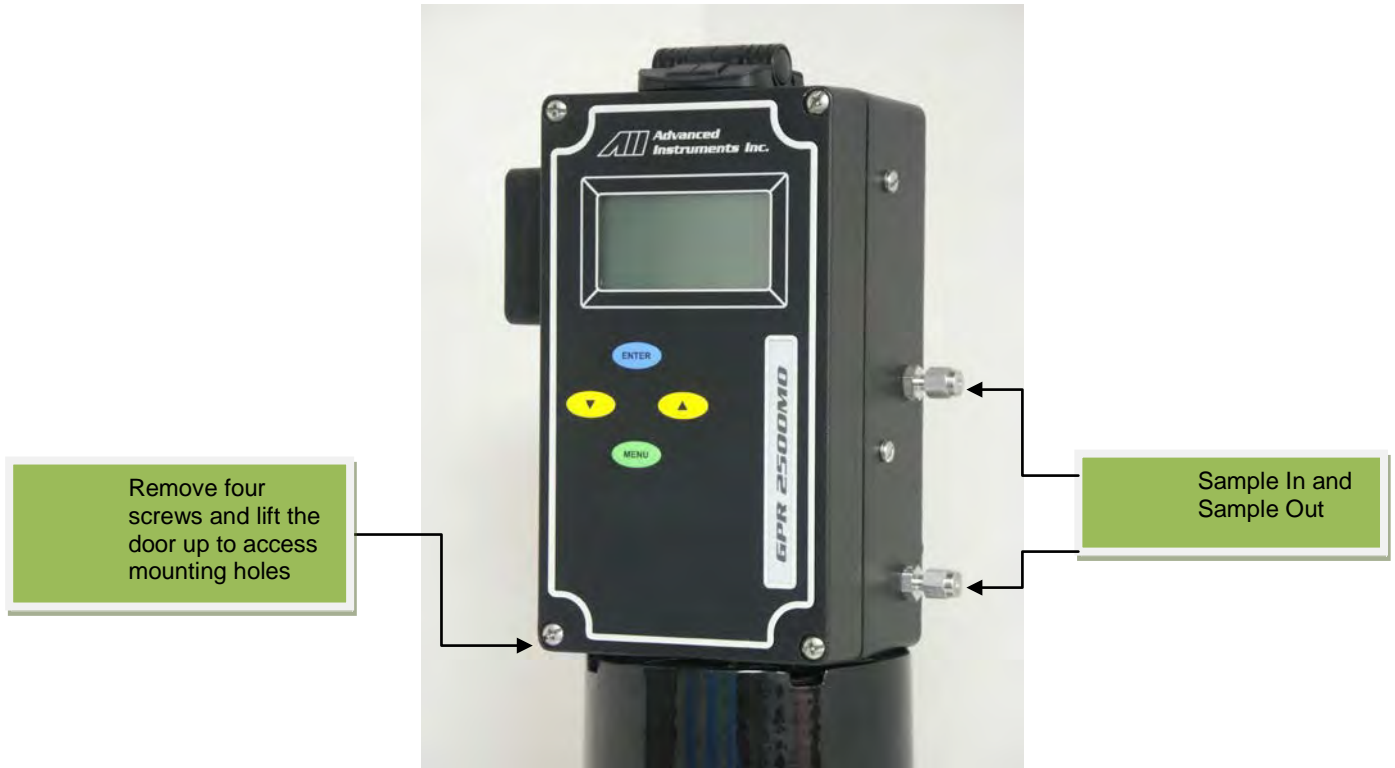

To facilitate servicing the interior of the transmitters, secure the transmitter to a vertical surface approximately 5 feet from the floor or a level accessible to service personnel. This requires the user to supply four (4) additional proper size screws and anchors.

To mount the transmitter, remove the four screws from the front door of the transmitter. Lift the door up. Use four screws/anchors and install the transmitter on a smooth vertical flat surface/wall.



Caution: Do not remove or discard the gaskets from the enclosure. Failure to reinstall the gaskets will void the NEMA 4 rating and the immunity to RFI/EMI.

The transmitters design provides immunity from RFI/EMI by maintaining a good conductive contact between the two halves of the enclosures via a conductive gasket (the smaller enclosure containing). The surfaces contacting the conductive gasket are unpainted. Do not paint these areas. Painting will negate the RFI/EMI protection.

Gas Connections

The GPR-2500 with its standard flow through configuration is designed for positive pressure samples and requires connections for incoming sample and outgoing vent lines. Zero and span inlet ports are offered as part of the optional sample systems. The user is responsible for calibration gases and other required components, see below.

Procedure

Caution: Do not change the factory setting until instructed to do in this manual.

If analyzer has no marking for sample inlet and sample vent, designate one of the bulkhead tube fittings as the VENT and the other as SAMPLE IN.

Regulate the sample pressure as described in "Pressure and Flow" section above.

Connect a 1/8" or 1/4" vent line to the compression fitting to be used for venting the sample.

Connect a 1/8" or 1/4" sample line to the compression fitting to be used to bring SAMPLE gas to the analyzer.

If equipped with optional SPAN and/or ZERO ports, connect the SPAN and the ZERO gas lines to the respective SPAN and ZERO ports of the analyzer

Set the SAMPLE, SPAN and the ZERO gas pressure between 5-30 psig.

Select sample gas and allow it to flow through the transmitters and set the flow rate to 1- 2 SCFH.

Note: If equipped with the optional H2S sample conditioning system: Regulate the pressure so that it does not exceed 30 psig.

Sample Flow Rate

Flow rates of 1-2 SCFH cause no appreciable change in the oxygen reading. However, flow rates above 5 SCFH may generate a backpressure and cause erroneous oxygen readings due to fact that the smaller diameter of the integral sample system tubing cannot vent the sample gas quickly at higher flow rates. If the analyzer is not equipped with an integral flow control valve, a flow control metering valve with a flow indicator upstream of the sensor must be installed to control the flow rate of the sample gas. A flow rate of 1-2 SCFH or 0.5-1 liter per minute is recommended for optimum performance.

Electrical Connections



Incoming power and signal output connections are made to a terminal block mounted inside a small enclosure attached on the side of the main enclosure. Bring power cable through the cable gland and secure the lugs of the cable to the terminal block as shown below. Connect the positive wire to the plus terminal and minus wire to the minus terminals of the terminal block.

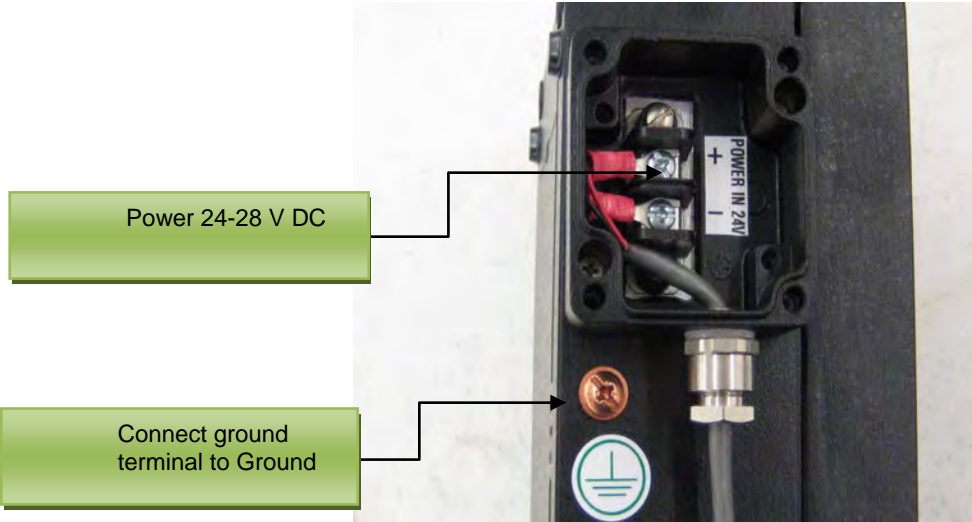

Do not supply voltage more than specified in this manual and noted near the power input terminal of the transmitter.

In order to maintain the intrinsic safety of the transmitter, the power must be supplied through an ATEX approved intrinsic safety barrier. The factory recommended intrinsic safety barrier is MTL 7706+ or equivalent. Without the use of intrinsic safety barrier or use of an improper safety barrier will void intrinsic safety rating (see below) of the transmitter.

The transmitter must be grounded by making a ground connection with the screw terminal marked as Ground.

With intrinsically safe power, this configuration of the GPR-2500 conforms to the ATEX Directives 94/9/CE for equipments for use in hazardous area. The analyzer meets the following area classification:



II 2 G
Ex ia IIB T4 Gb
T_{amb} -20°C to +50°C



Avoid electrostatic discharge – Clean all non-metallic surfaces with a damp cloth only.

With the use of recommended intrinsic safety barrier, the GPR-2500 also meets the intrinsic safety standards required for use in Class 1, Division 1, Group C, D hazardous areas.

Installation in Hazardous Area

The GPR-2500 may be installed in a hazardous area. However, in order to maintain the intrinsic safety rating of the transmitter, total power coming to the transmitter must be limited to a safe level. This can be achieved by using the recommended safety barrier, MTL7706+ or equivalent. The intrinsic safety barrier has a built in power limiting circuitry that keeps the maximum power going to the transmitter to a safe level even under fault conditions.



The maximum supply to the safety barrier is limited to 36 volts but the lowest voltage required is 24 VDC. The intrinsic safety barrier must be installed in a safe area.

Output Connection

The 4-20mA current output is measured in the power loop by connecting a current measuring device between the negative terminal of the power source and the negative terminal, marked (-), of the power input terminal block located in the small enclosure. The current flow is from positive terminal of the power source to the positive terminal of the transmitter and back to the negative terminal of the power source.

To measure the 4-20 mA signal output, connect an ammeter, as illustrated below. To convert the 4-20 mA in to 1-5 VDC, place a 250 Ohms resistor in place of the current meter and measure the voltage across the resistor.

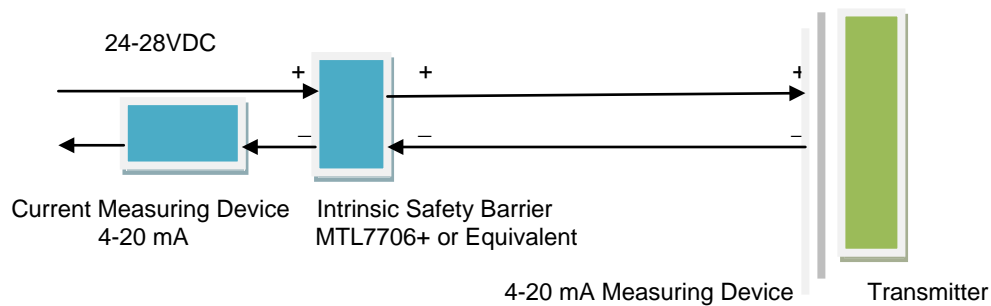

Caution: To prevent accidental damage to the Intrinsic Safety Barrier, it is highly recommended that an additional Fuse rated at 100 mA at 30 VDC be placed ahead of the intrinsic safety barrier.

Procedure

- Power requirements consist of a two wire shielded cable, intrinsic safety barrier and a 24-36 V DC power supply.
- Mount the intrinsic safety barrier on the din rail or other mounting device and ensure that the mounting bracket of the intrinsic safety barrier is connected to the ground.
- Connect the power to the two terminals of the intrinsic safety barrier marked as SAFE (terminal 1 + and terminal 2 -)
- Connect a two wire shielded cable to the two terminals of the intrinsic safety barrier marked as HAZ (terminal 3 + and terminal 4 -)
- Run the shielded cable from HAZ through a proper conduit and through the cable gland and connect the two ends of the shielded cable to the two terminals of the transmitter marked as + and -
- Replace the cover of the small power input enclosure.
- Connect the ground terminal of the transmitter to a proper ground.
- Connect the ground of the safety barrier to the mounting rail (without rail ground, the transmitter will not power up)

Installing Oxygen Sensor

The GPR-2500 Oxygen Transmitter is equipped with an integral flow-through Delrin adopter with SS fittings and tubing. The oxygen sensor simply screws in the adopter. The seal between the flow-through adopter and the oxygen sensor is achieved by an integral o-ring (over the threaded spout) and the steeped sealing surface of the flow-through adopter. Optional stainless steel sensor housing is available for oxygen measurements in highly corrosive applications. The transmitter has been tested and calibrated by the manufacturer prior to shipment and is fully operational from the shipping container.



Caution: All transmitters must be calibrated once the installation has been completed and periodically thereafter as described below. Following the initial installation and calibration, allow the transmitters to stabilize for 1-2 hours and re-calibrate the transmitter with a certified span gas.



Caution: DO NOT dissect the oxygen sensor. The sensor contains a corrosive liquid electrolyte that could be harmful if touched or ingested, refer to the Material Safety Data Sheet in Section 10. Avoid contact with any liquid or crystal type powder in or around the sensor or sensor housing, as either could be a form of electrolyte. Leaking sensors should be disposed off in a manner similar to that of a common battery in accordance with local regulations.



Avoid Electrostatic Discharge – Clean all non-metallic surfaces with a damp cloth only.

Procedure

1. Remove the four (4) screws securing the lid of the transmitter to the bottom of the enclosure.
2. Lift the door up until you hear a “click” sound (the hinge of the door will lock itself thus preventing the door from falling back). **Caution:** Do not remove the gaskets from either the enclosure. Failure to reinstall the gasket will void the NEMA 4 rating and EMI/RFI protection.



3. Remove the oxygen sensor from the bag.
4. Remove the spring from inside of the round metal connector of the sensor (the spring keeps the positive and negative terminals of the sensor shorted to ensure that sensor is ready to use in a relatively short period of time after installation). **Note:** After removing the spring, the sensor must be connected to the sensor cable immediately. Failure to do so will prolong the time the sensor will require to stabilize.
5. Screw the oxygen sensor into the sensor housing. Finger tighten plus one eighth (1/8) turn to ensure a good seal between the sensor housing and the o-ring affixed to the sensor.
6. Assure the keyway registration of the female plug on the cable and male receptacle on the sensor match up.
7. Push the female plug (including the knurled lock nut) molded to the cable into the male receptacle attached to the new sensor.
8. Screw the knurled lock nut attached with the cable onto to the male connector of the sensor.

9. Close the door of the enclosure and tighten the four screws assuring that the gasket is firmly in place between the door and the body of the enclosure.
10. Proceed to calibration.

Span Gas Preparation

The GPR-2500 can be calibrated by using ambient air. However, it can also be calibrated by using a certified span gas. Air calibration can be achieved right after installing the sensor in the housing. Subsequent calibration, where the sensor has been exposed to a sample gas, air calibration can be achieved by either removing the sensor from the sensor housing or by pushing the air through the sensor housing.

Establishing Power

Once the two power input wires of the shielded cable are properly connected to the terminals inside the enclosure as described above, connect the other end of the two wires to a suitable 24-28 VDC power supply such as a battery, PLC, DCS, etc.

The digital display responds instantaneously. When power is applied, the transmitter performs several self-diagnostic system status checks termed as "START-UP TEST" as illustrated below:

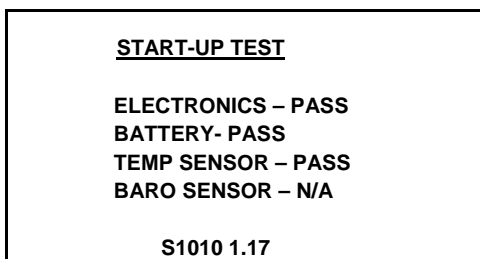

After self diagnostic tests, the analyzer turns itself into the sampling mode. And displays oxygen contents the sensor is exposed to, the analysis range, and the ambient temperature.

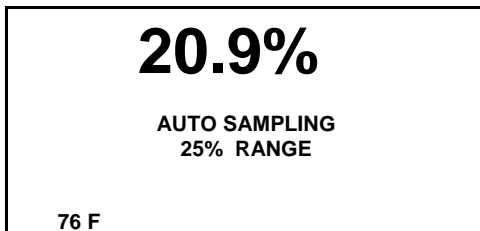

Menu Navigation

The four (4) pushbuttons located on the front of the transmitter control all of the micro-processor functions:

Blue ENTER (select)
Yellow UP ARROW
Yellow DOWN ARROW
Green MENU (escape)

Main Menu

To access the MAIN MENU, press the MENU (ESC) key and the following screen will appear.

MAIN MENU

SELECT RANGE
 CALIBRATION
 VIEW HISTORY
 SYSTEM OPTIONS

This screen shows various options available. You can use the UP and DOWN arrow keys to move the cursor and highlight the desired function. After moving the cursor to the desired function, you can press ENTER to get to that function.

The GPR-2500 analyzer is equipped with four (4) standard measuring ranges (see specification) and provides users with a choice of sampling modes. By accessing the MAIN MENU, users may select either the AUTO SAMPLING (ranging) or MANUAL SAMPLING (to lock on a single range) mode.

Auto/Manual Sampling

Access the MAIN MENU by pressing the MENU key.

Advance the reverse shade cursor using the ARROW keys to highlight SELECT RANGE and press ENTER.

The display will show *AUTO and the actual range of analysis. Press the ENTER to select MANUAL RANGE and advance the cursor to the desired RANGE and press ENTER.

The following display appears:

MAIN MENU

SELECT RANGE
 CALIBRATION
 VIEW HISTORY
 SYSTEM OPTIONS

SELECT RANGE

*AUTO
 25%
 10%
 5%
 *1%

76 F

In the AUTO range, the display will shift to the next higher range when the oxygen reading exceeds 99.9% of the upper limit of the current range. The display will shift to the next lower range when the oxygen reading drops to 85% of the upper limit of the next lower range. In MANUAL range, the analyzer will be locked on the selected range. If the oxygen value goes above 25% of the upper limit of the MANUAL selected range, an OVER RANGE warning will be displayed.

1.25 %

OVERRANGE
MANUAL SAMPLING
1% RANGE

76 F

Once the OVER RANGE warning appears the user must advance to the next higher range.

NOTE: With oxygen reading above 25% of the selected range, the analog signal output will increase but will freeze at a maximum value of 1.2 V. After the oxygen reading falls below the full scale range, the voltage signal will become normal.

Analyzer Calibration

The electrochemical oxygen sensors generate an electrical current that is **linear** or proportional to the oxygen concentration in a sample gas. In the absence of oxygen the sensor exhibits an **absolute zero**, i.e., the sensor does

not generate a current output in the absence of oxygen. Given the properties of linearity and an absolute zero, a single point calibration is possible.

The analyzer is equipped with “Zero Calibration” feature. However, as described below, zero calibration is recommended only when the application (or user) demands optimum accuracy of below 5% of the most sensitive or lowest range available on the analyzer. For example, if the user requires analysis of a sample gas below 0.05%, zero calibration may be required.

Span calibration, it is necessary to adjust the analyzer sensitivity for accurate measurements of oxygen by using a standardized (certified) oxygen or by using ambient air (20.9%).

Zero Calibration

The maximum zero offset correction is limited to a maximum of 50% of the lowest (most sensitive) range for positive zero offset and 10% of the lowest range for negative zero offset.

Zero calibration should be carried out after the span calibration and once performed should not have to be repeated with subsequent span calibrations. Normally, zero calibrations are performed when a new sensor is installed or changes are made in the sample system connections. Allow the ZERO gas to flow through the analyzer and wait until the signal has dropped to a low value and is stable.

Access the MAIN MENU by pressing the MENU key.
Advance the reverse shade cursor using the ARROW keys to highlight CALIBRATION.
Press the ENTER key to select the highlighted menu option.

The following displays appear:

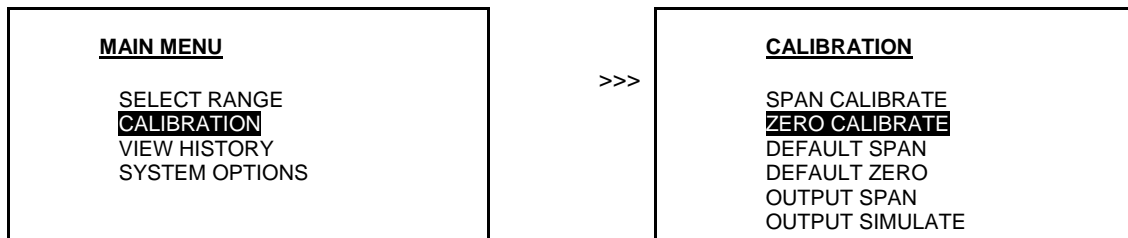

Advance the reverse shade cursor using the ARROW keys to highlight ZERO CALIBRATE.
Press the ENTER key to select the highlighted menu option.

The following displays appear:

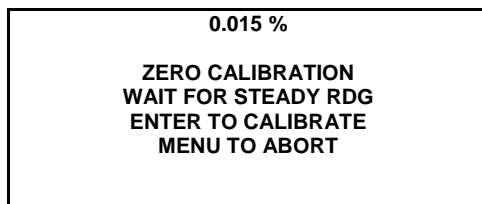

Wait until the analyzer reading stabilizes (depending on the history of the sensor, it may take a few minutes to several hours) and then press the ENTER key to calibrate (or MENU key to abort).

If the offset is less than 50% of the lowest range, by pressing ENTER will pass the calibration and the analyzer will return to the Sample mode. On the other hand, if the offset is above 50%, pressing ENTER will fail calibration and the analyzer will return to Sample mode without completing the Zero calibration.

Both the Zero Calibrate and Span Calibrate functions result in the following displays:

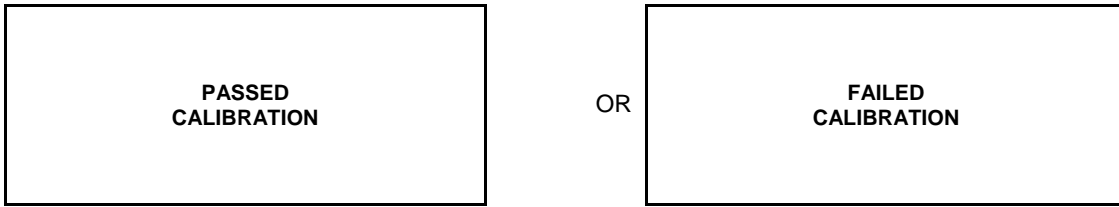

Default Zero

This feature will eliminate any previous zero calibration adjustment and display the actual signal output of the sensor at a specified oxygen concentration. This feature allows the user to ensure that the accumulative zero offset never exceeds 50% of the lowest range limit. To perform Default Zero, Access the MAIN MENU by pressing the MENU key.

Advance the reverse shade cursor using the ARROW keys to highlight CALIBRATION. Press the ENTER key to select the highlighted menu option. The following displays appear:

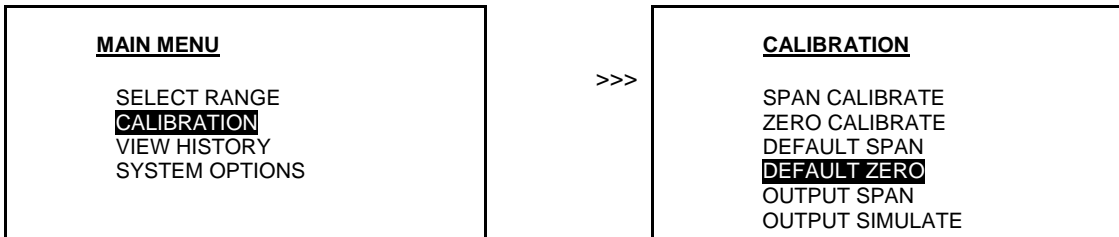

Advance the reverse shade cursor using the ARROW keys to highlight DEFAULT ZERO. Press the ENTER key to select the highlighted menu option.

The following display appears and after 3 seconds the system returns to the SAMPLING mode:

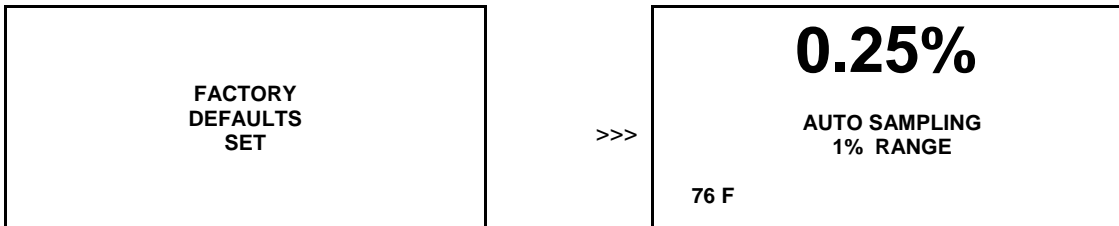

Analog Output Adjustment-Calibrate Output Span

In rare instances the 0-1 V signal output may not agree with the reading displayed on the LCD. This feature enables the user to adjust the 0-1 V signal output.

Access the MAIN MENU by pressing the MENU key. Advance the reverse shade cursor using the ARROW keys to highlight CALIBRATION. Press the ENTER and then advance the cursor to OUTPUT SPAN and press ENTER. The following displays appear:

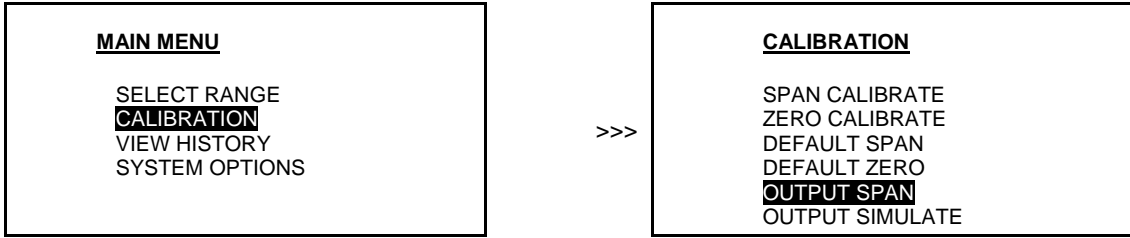

Press the ENTER key to select the highlighted menu option and the following display appears:

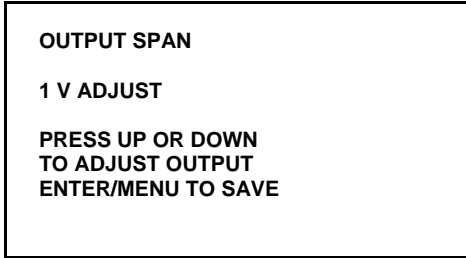

By pressing UP or DOWN arrow, the signal output will change. Keep pressing the Up or DOWN key until the output is 1V. Note: To perform "Calibrate-Output Span", an external recording device must be connected to the signal output port of the analyzer.
 Press ENTER to SAVE the changes.

Span Calibration Procedure

Air Calibration

This procedure requires only a source of clean ambient air and removal of the sensor from its flow housing. Access the interior of the analyzer by removing the 4 clamps securing the door of the analyzer.

Caution: Do not remove the gaskets from the enclosure. Failure to do so will void the NEMA rating. Remove the sensor from the screw-in sensor housing or push the air through the analyzer SAMPLE IN thus exposing the sensor to ambient air or alternatively, flow a certified span gas through the analyzer. Advance the cursor on the MAIN MENU to CALIBRATE and press ENTER. Advance the cursor to SPAN CALIBRATION and press ENTER

The following displays appear:

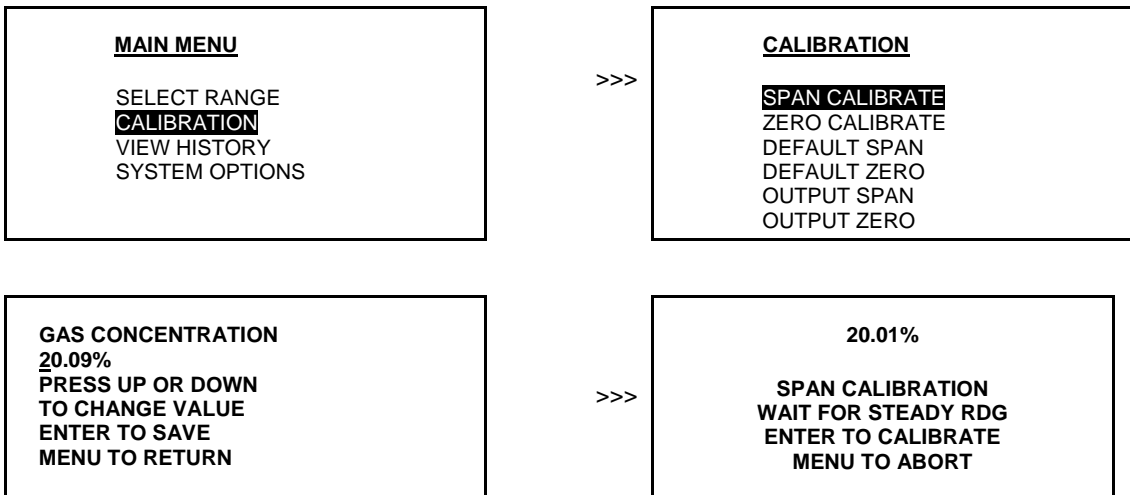

By using the UP or DOWN arrow keys, enter the appropriate digit where the cursor is blinking
Press the ENTER key to advance the underline cursor right or press the MENU key to advance the underline cursor left to reach to the desired digit of the gas value.

Repeat until the complete span value has been entered.

In the example above, a span value of 20.09% has been entered.

After the span value has been entered, the analyzer will prompt to press the ENTER key to accept SPAN CALIBRATION or MENU to escape.

Caution: Allow the analyzer reading to stabilized before accepting calibration.

After successful calibration, the analyzer will display a message "Passed Calibration" and return to the Sample mode.

NOTE: The analyzer is allowed to accept calibration when O2 reading is within the acceptable value. If the O2 reading is outside of this limit, by pressing ENTER to accept calibration will result in "Failed Calibration" and return to the Sample mode without completing Span calibration. After pressing ENTER either of the following two messages will be displayed and the analyzer will return to SAMPLE mode.

PASSED
CALIBRATION

OR

FAILED
CALIBRATION

Default Span

The software will set the SPAN adjustment based on the average output of the oxygen at a specific oxygen concentration and erase any previous span calibration data. For example, with factory default settings, when a span gas is introduced, the micro-processor will display oxygen reading within $\pm 30\text{-}50\%$ of the span gas value, indicating that the sensor output is within the specified limits. This feature allows the user to check the sensor's signal output without removing it from the sensor housing.

Access the MAIN MENU by pressing the MENU key.
Advance the reverse shade cursor using the ARROW keys to highlight CALIBRATION.
Press the ENTER key to select the highlighted menu option.

The following display appears:

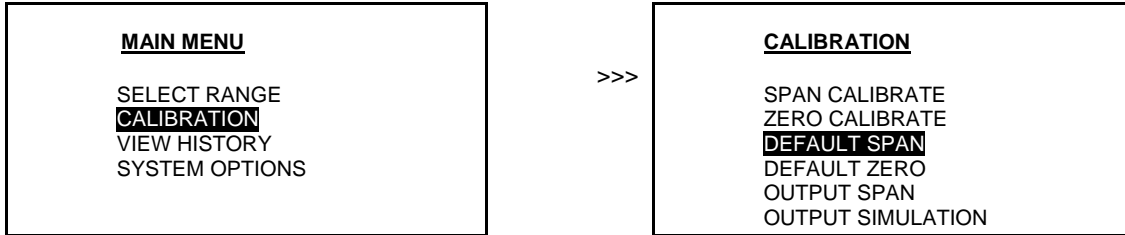

Advance the reverse shade cursor using the ARROW keys to highlight DEFAULT SPAN.
Press the ENTER key to select the highlighted menu option.

The following displays appear and after 3 seconds the system returns to the SAMPLING mode:

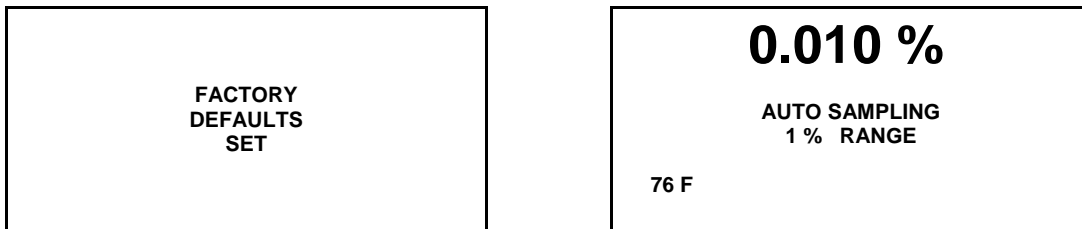

Analog Output Check- Output Simulate

This feature allows the user to simulate the electronics and the signal output. A known current is added to the analyzer electronics internally to generate equivalent analog signal output. This feature allows the user to check all interconnections from the analyzer to the signal output recording device before installation of sensor thus preventing the user to open the sensor bag before the analyzer installation is complete and satisfactory. To simulate signal output

Access the MAIN MENU by pressing the MENU key.
Advance the reverse shade cursor using the ARROW keys to highlight CALIBRATION and then select OUTPUT SIMULATE.
Press the ENTER key to select the highlighted menu option.

The following displays appear:

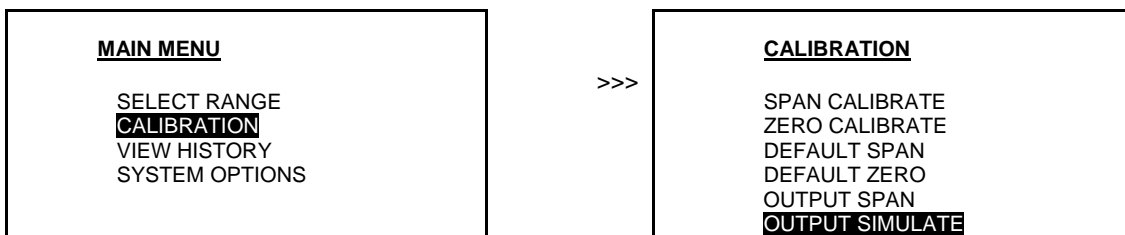

```

OUTPUT SIMULATION

0% SPAN
0.00 V

PRESS UP OR DOWN TO ADJUST
OUTPUT ENTER/MENU TO RETURN
    
```

Pressing UP or DOWN key will increase or decrease the output by 5% of the full scale signal each time. Check the output on the external recording device or voltmeter/ammeter. The output on the external recording would be the % of the full scale signal selected, for example, 0% will represent 0.00 V, 25% value will represent 0.25 V and 50% span value will represent 0.5 V of the 0-1 V full scale. After SIMULATION is complete, press ENTER/MENU key to return to SAMPLE mode.

Note: To perform "Calibrate-Output Simulation", an external recording device must be connected between the negative terminal of the power source and negative terminal of the transmitter.

Analog Output Check- Output Calibrate

In certain cases, the full scale analog may not match with full scale display. This feature allows the user to adjust the electronics so that the full scale display matches with full scale analog signal output. To calibrate full scale signal output

Access the MAIN MENU by pressing the MENU key.

Advance the reverse shade cursor using the ARROW keys to highlight CALIBRATION and then select OUTPUT SIMULATE.

Press the ENTER key to select the highlighted menu option.

The following displays appear:

```

MAIN MENU

SELECT RANGE
CALIBRATION
VIEW HISTORY
SYSTEM OPTIONS
    
```

>>>

```

CALIBRATION

SPAN CALIBRATE
ZERO CALIBRATE
DEFAULT SPAN
DEFAULT ZERO
OUTPUT CALIBRATE
OUTPUT SIMULATE
    
```

```

OUTPUT SIMULATION

20.0 mA ADJUST

PRESS UP OR DOWN TO ADJUST
OUTPUT ENTER/MENU TO RETURN
    
```

Pressing UP or DOWN key will increase or decrease the full scale output signal each time. Check the output on the external recording device or voltmeter/ammeter. Repeat this step until the out equals the full scale analog signal expected, for example 20 mA in the present case. After OUTPUT CALIBRATION is complete, press ENTER/MENU key to return to SAMPLE mode.

Sampling a Gas

GPR-2500 Oxygen Analyzer requires a positive pressure to flow the sample gas across the sensor to measure the oxygen concentration in a sample gas. If a positive sample pressure is not available, install an external sample pump to push the sample through the analyzer; see the option of using a sample pump as described above.

Procedure

Following calibration, the analyzer will return to the SAMPLE mode and ready for sampling the gas.

Select the desired sampling mode - auto or manual – as described above.

Use a suitable tubing to transport the sample gas to the analyzer

The main consideration is to eliminate any air leaks which can affect oxygen measurements.

For sample gases under positive pressure, the user must provide a means of controlling the inlet pressure between 5-30 psig.

For sample gases under atmospheric or slightly negative pressure, an optional integral sampling pump or an external pump is necessary to push the sample through the sensor housing. Generally, when using a low voltage DC pump, no pressure regulation or flow control device is involved. However, a flow meter upstream of analyzer is recommended to ensure that the sample flow is adequate and steady.

Assure the sample is adequately vented for optimum response and recovery – and safety.

Allow the oxygen reading to stabilize for approximately 2 minutes at each sample point.

View History

This feature allows the user to view the maximum, minimum and average O₂ concentration, maximum ambient temperature, the number of days the sensor has been in service (at the time of installation and first calibration, the user must enter YES to confirm "new sensor") and the number of days since the last calibration was done.

System Options

This features allows the user to

1. Set security; password protected operation
2. Define ranges; choose a range between two ranges, for example, 2% full scale instead of 5% full scale.
3. Display signal below 0.00; negative signal, yes or no.

To enter password, from system option menu, select SECURITY, then enter four digit PASS CODE, numeral numbers only and press ENTER. Then select AUTO LOCK option and enter the number of minutes after which access to MENU options will be locked (access allowed only after entering the PASS CODE).

In the vent the PASS CODE is lost, enter the factory default PASS CODE 2855 to access the MENU and then reenter the new PASS CODE.

Choosing the option to display negative number will allow the user to see the display below 0.00 but the output will be locked at 0.00 VDC.

Standby

The transmitter has no special storage requirements.

The sensor should remain connected during storage periods.

Store the transmitter with the power OFF at a safe location and away from a direct heating source.

If storing for an extended period of time protect the analyzer from dust, heat and moisture.

6. Maintenance

Generally, replacing the oxygen sensor is the extent of the maintenance requirements of this transmitter. Should any other component, e.g., PCB, LCD, Safety Barrier, fail consult factory before proceeding for repair.

To replace sensor, refer to the section "INSTALLATION THE OXYGEN SENSOR" above.

Serviceability: Except for replacing the oxygen sensor, there are no parts inside the transmitter for the operator to service. Only trained personnel with the authorization of their supervisor should conduct maintenance.

7. Spare Parts

Recommended spare parts for the GPR-2500 Oxygen Transmitter:

Item No.	Description
GPR-11-32-4	Oxygen Sensor, for measuring O2 in inert gases
XLT-11-24-4	Oxygen Sensor, for measuring O2 in gases containing CO2

Other spare parts:

Item No.	Description
A-3051	Sensor Housing Flow Adapter
BARR-1001	Intrinsic Safety Barrier MTL7706+
MTR-1010	Meter Digital Panel LCD
A-1161-IS-2 Rev C4	PCB Assembly Main / Display
A-1182	PCB Assembly 4-20 Loop Current Control

8. Troubleshooting

Symptom	Possible Cause	Recommended Actions
Slow recovery to low oxygen	<p>At installation, defective sensor</p> <p>Air leak in sample system connection(s)</p> <p>Abnormality in zero gas Damaged in service - prolonged exposure to air, electrolyte leak Sensor nearing end of life</p>	<p>Replace sensor if recovery unacceptable or O₂ reading fails to reach 20% of lowest range</p> <p>Leak test the entire sample system: Vary the flow rate, if the O₂ reading changes inversely with the change in flow rate indicates an air leak - correct source of leak</p> <p>Qualify zero gas (using portable transmitter)</p> <p>Replace sensor</p> <p>Replace sensor</p>
High O ₂ reading after installing or replacing sensor	<p>Transmitter calibrated before sensor stabilized caused by:</p> <ol style="list-style-type: none"> 1) Air leak in sample system connection(s) 2) Abnormality in zero gas 	<p>Allow O₂ reading to stabilize before making the span/calibration adjustment</p> <p>Continue purge with zero gas</p> <p>Leak test the entire sample system (above)</p> <p>Qualify zero gas (using portable transmitter)</p>
High O ₂ reading Sampling	<p>Flow rate exceeds limits</p> <p>Pressurized sensor</p> <p>Improper sensor selection</p>	<p>Correct pressure and flow rate</p> <p>Remove restriction on vent line</p> <p>Replace GPR/PSR sensor with XLT sensor when CO₂ or acid gases are present</p>
Response time slow	<p>Air leak, dead legs, distance of sample line, low flow rate, volume of optional filters and scrubbers</p>	<p>Leak test (above), reduce dead volume or increase flow rate</p>
O ₂ reading doesn't agree with expected O ₂ values	<p>Pressure and temperature of the sample is different than span gas</p> <p>Abnormality in gas</p>	<p>Calibrate the transmitter (calibrate at pressure and temperature of sample)</p> <p>Qualify the gas (use a portable transmitter)</p>
Erratic O ₂ reading or No O ₂ reading	<p>Change in sample pressure</p> <p>Bad sensor cable connection</p> <p>Defective sensor</p>	<p>Calibrate the transmitter (calibrate at pressure and temperature of sample gas)</p> <p>Check sensor cable connections, replace sensor cable if necessary</p> <p>Replace sensor and return sensor to the factory for warranty determination</p>

	Liquid covering sensing area	Sensor: Replace if leaking and return it to the factory for warranty determination
	Improper sensor selection	Replace GPR/PSR sensor with XLT sensor when CO ₂ or acid gases are present. Consult factory.
	Presence of interference gases	Replace sensor and install scrubber
	Unauthorized maintenance	Consult factory.
	Sensor nearing end of life	Replace sensor
Erratic O ₂ reading or Negative O ₂ reading or No O ₂ reading accompanied by electrolyte leakage	Pressurizing the sensor by flowing gas to the sensor with the vent restricted or SHUT OFF valve closed and suddenly removing the restriction draws a vacuum on the sensor or partially opening the valves upstream of the transmitter when using a pump downstream of the transmitter to draw sample from a process at atmospheric pressure or a slight vacuum. Placing a vacuum on the sensor in excess 4" of water column is strongly discouraged. A premature adjustment of the ZERO OFFSET potentiometer is a common problem	Confirm sample is vented to atmospheric pressure. Confirm no restriction on vent line. Zero the transmitter. If not successful replace the sensor Avoid drawing a vacuum on the sensor. From MAIN MENU select DEFAULT ZERO

9. Warranty

The design and manufacture of GPR Series oxygen analyzers, monitors and oxygen sensors are performed under a certified Quality Assurance System that conforms to established standards and incorporates state of the art materials and components for superior performance and minimal cost of ownership. Prior to shipment every analyzer is thoroughly tested by the manufacturer and documented in the form of a Quality Control Certification that is included in the Owner's Manual accompanying every analyzer. When operated and maintained in accordance with the Owner's Manual, the units will provide many years of reliable service.

Coverage

Under normal operating conditions, the monitor, analyzers and sensor are warranted to be free of defects in materials and workmanship for the period specified in accordance with the most recent published specifications, said period begins with the date of shipment by the manufacturer. The manufacturer information and serial number of this analyzer are located on the rear of the analyzer. Advanced Instruments Inc. reserves the right in its sole discretion to invalidate this warranty if the serial number does not appear on the analyzer.

If your Advanced Instruments Inc. monitor, analyzer and/or oxygen sensor is determined to be defective with respect to material and/or workmanship, we will repair it or, at our option, replace it at no charge to you. If we choose to repair your purchase, we may use new or reconditioned replacement parts. If we choose to replace your Advanced Instruments Inc. analyzer, we may replace it with a new or reconditioned one of the same or upgraded design. This warranty applies to all monitors, analyzers and sensors purchased worldwide. It is the only one we will give and it sets forth all our responsibilities. There are no other express warranties. This warranty is limited to the first customer who submits a claim for a given serial number and/or the above warranty period. Under no circumstances will the warranty extend to more than one customer or beyond the warranty period.

Limitations

Advanced Instruments Inc. will not pay for: loss of time; inconvenience; loss of use of your Advanced Instruments Inc. analyzer or property damage caused by your Advanced Instruments Inc. analyzer or its failure to work; any special, incidental or consequential damages; or any damage resulting from alterations, misuse or abuse; lack of proper maintenance; unauthorized repair or modification of the analyzer; affixing of any attachment not provided with the analyzer or other failure to follow the Owner's Manual. Some states and provinces do not allow limitations on how an implied warranty lasts or the exclusion of incidental or consequential damages, these exclusions may not apply.

Exclusions

This warranty does not cover installation; defects resulting from accidents; damage while in transit to our service location; damage resulting from alterations, misuse or abuse; lack of proper maintenance; unauthorized repair or modification of the analyzer; affixing of any label or attachment not provided with the analyzer; fire, flood, or acts of God; or other failure to follow the Owner's Manual.

Service

Call Advanced Instruments Inc. at 909-392-6900 (or e-mail info@aii1.com) between 7:30 AM and 5:00 PM Pacific Time Monday thru Thursday or 8:00 AM to 12:00 pm on Friday. Trained technicians will assist you in diagnosing the problem and arrange to supply you with the required parts. You may obtain warranty service by returning you analyzer, postage prepaid to:

Advanced Instruments Inc.
2855 Metropolitan Place
Pomona, Ca 91767 USA
Tel: 909 392 6900

Be sure to pack the analyzer securely. Include your name, address, telephone number, and a description of the operating problem. After repairing or, at our option, replacing your Advanced Instruments Inc. analyzer, we will ship it to you at no cost for parts and labor.

10. MSDS – Material Safety Data Sheet

Product Identification

Product Name	Oxygen Sensor Series - PSR, GPR, All, XLT
Synonyms	Electrochemical Sensor, Galvanic Fuel Cell
Manufacturer	Advanced Instruments Inc., 2855 Metropolitan Place, Pomona, CA 91767 USA
Emergency Phone Number	909-392-6900
Preparation / Revision Date	January 1, 1995
Notes	Oxygen sensors are sealed, contain protective coverings and in normal conditions do not present a health hazard. Information applies to electrolyte unless otherwise noted.

Specific Generic Ingredients

Carcinogens at levels > 0.1%	None
Others at levels > 1.0%	Potassium Hydroxide or Acetic Acid, Lead
CAS Number	Potassium Hydroxide = KOH 1310-58-3 or Acetic Acid = 64-19-7, Lead = Pb 7439-92-1
Chemical (Synonym) and Family	Potassium Hydroxide (KOH) – Base or Acetic Acid (CH ₃ CO ₂ H) – Acid, Lead (Pb) – Metal

General Requirements

Use	Potassium Hydroxide or Acetic Acid - electrolyte, Lead - anode
Handling	Rubber or latex gloves, safety glasses
Storage	Indefinitely

Physical Properties

Boiling Point Range	KOH = 100 to 115° C or Acetic Acid = 100 to 117° C
Melting Point Range	KOH -10 to 0° C or Acetic Acid – NA, Lead 327° C
Freezing Point	KOH = -40 to -10° C or Acetic Acid = -40 to -10° C
Molecular Weight	KOH = 56 or Acetic Acid – NA, Lead = 207
Specific Gravity	KOH = 1.09 @ 20° C, Acetic Acid = 1.05 @ 20° C
Vapor Pressure	KOH = NA or Acetic Acid = 11.4 @ 20° C
Vapor Density	KOH – NA or Acetic Acid = 2.07
pH	KOH > 14 or Acetic Acid = 2-3
Solubility in H ₂ O	Complete
% Volatiles by Volume	None
Evaporation Rate	Similar to water
Appearance and Odor	Aqueous solutions: KOH = Colorless, odorless or Acetic Acid = Colorless, vinegar-like odor

Fire and Explosion Data

Flash and Fire Points	Not applicable
Flammable Limits	Not flammable
Extinguishing Method	Not applicable
Special Fire Fighting Procedures	Not applicable
Unusual Fire and Explosion Hazards	Not applicable

Reactivity Data

Stability	Stable
Conditions Contributing to Instability	None
Incompatibility	KOH = Avoid contact with strong acids or Acetic Acid = Avoid contact with strong bases
Hazardous Decomposition Products	KOH = None or Acetic Acid = Emits toxic fumes when heated
Conditions to Avoid	KOH = None or Acetic Acid = Heat

Spill or Leak

Steps if material is released	Sensor is packaged in a sealed plastic bag, check the sensor inside for electrolyte leakage. If the sensor leaks inside the plastic bag or inside an analyzer sensor housing do not remove it without rubber or latex gloves and safety glasses and a source of water. Flush or wipe all surfaces repeatedly with water or wet paper towel (fresh each time).
Disposal	In accordance with federal, state and local regulations.

Health Hazard Information

Primary Route(s) of Entry	Ingestion, eye and skin contact
Exposure Limits	Potassium Hydroxide - ACGIH TLV 2 mg/cubic meter or Acetic Acid - ACGIH TLV / OSHA PEL 10 % (TWA), Lead - OSHA PEL .05 mg/cubic meter
Ingestion	Electrolyte could be harmful or fatal if swallowed. KOH = Oral LD50 (RAT) = 2433 mg/kg or Acetic Acid = Oral LD50 (RAT) = 6620 mg/kg
Eye	Electrolyte is corrosive and eye contact could result in permanent loss of vision.
Skin	Electrolyte is corrosive and skin contact could result in a chemical burn.
Inhalation	Liquid inhalation is unlikely.
Symptoms	Eye contact - burning sensation. Skin contact - soapy slick feeling.
Medical Conditions Aggravated	None
Carcinogenic Reference Data	KOH and Acetic Acid = NTP Annual Report on Carcinogens - not listed; LARC Monographs - not listed; OSHA - not listed
Other	Lead is listed as a chemical known to the State of California to cause birth defects or other reproductive harm.

Special Protection Information

Ventilation Requirements	None
Eye	Safety glasses
Hand	Rubber or latex gloves
Respirator Type	Not applicable
Other Special Protection	None

Special Precautions

Precautions	Do not remove the sensor's protective Teflon and PCB coverings. Do not probe the sensor with sharp objects. Wash hands thoroughly after handling. Avoid contact with eyes, skin and clothing. Empty sensor body may contain hazardous residue.
Transportation	Not applicable

Appendix A

Electrical power must be within the recommended range (Maximum 36 VDC, Minimum 24 VDC). The power to the transmitter must be provided through an ATEX approved intrinsic safety barrier. Factory recommended intrinsic safety barrier is MTL7706+. This intrinsic safety barrier has the following rating

 II (1) GD
[Ex ia] IIC

The barrier has a built in electronic circuitry that limit the total power delivered to the transmitter to a safe level even under fault conditions.



Failure to use the intrinsic safety barrier will void the intrinsic safety rating of the transmitter.
The transmitter enclosure must be grounded with a good ground connection to prevent accidental damage to the transmitter.

Appendix B

Matching - LCD Display with 4-20mA Output

In rare instances the 4-20mA signal output may not agree with the reading displayed on the LCD. The Output Zero and Output Span features enable the user to adjust the 4mA and 20 mA signal output matching with the reading displayed by the LCD.

For optimum accuracy make two separate adjustments as follows:

1. OUTPUT ZERO feature: To adjust the 4mA signal output and requires zero gas.
 2. OUTPUT SPAN feature: To adjust the 20mA signal output and requires span gas near full range.
- Note: In the field or in the absence of the preferred gases, use the OUTPUT SPAN feature and adjust the 20mA signal output using the span gas available.

Procedure – regardless of type of adjustment:

1. When you select OUTPUT ZERO OR OUTPUT SPAN, the microprocessor defaults to 100% to start.
2. The “actual” 4-20mA signal output will be adjusted to the “theoretical” value of the LCD display.
3. Adjustment general rule:
 - a) If the actual 4-20mA value < the theoretical LCD value, the adjustment value will be > 100%.
 - b) If the actual 4-20mA value > the theoretical LCD value, the adjustment value will be < 100%.
4. Convert the “actual” reading of the LCD display to the “theoretical” 4-20mA as follows:
 - a) Divide the “actual” (% or percent) LCD reading by the value of the span gas available.
 - b) Multiply 16mA (20mA – 4mA) times the “result of a.”
 - c) Add 4mA plus the “result of b.” to obtain the “theoretical” 4-20mA signal output value.
5. Adjustment value: Divide the theoretical by the actual 4-20mA values and multiply by 100.
6. Enter the adjustment value via OUTPUT ZERO or OUTPUT SPAN routines described below.

Example: Analyzer reading is 60 % oxygen (100 % range) on 84 % span gas, 4-20mA signal output at PLC is 24mA

Solution:

- a) Use OUTPUT SPAN feature to make the adjustment.
- b) Adjustment will be < 100% (default value of OUTPUT SPAN feature).
- c) 13.6mA is the “theoretical” 4-20mA converted from the “actual” reading of the LCD.
 - 60 % divided by 84 % = 0.71 or 71%
 - 16mA multiplied by 0.71 = 11.36mA
 - 4mA plus 11.36mA = 15.36mA “theoretical” 4-20mA signal output value
- d) 15.36mA divided by 24mA the “actual” 4-20mA value = 64.0 adjustment value
- e) Enter 64.0 via OUTPUT SPAN procedure below.

Output Zero

Access the MAIN MENU by pressing the MENU key.
 Advance the reverse shade cursor using the ARROW keys to highlight CALIBRATION.
 Press the ENTER key to select the highlighted menu option.
 The following displays appear:

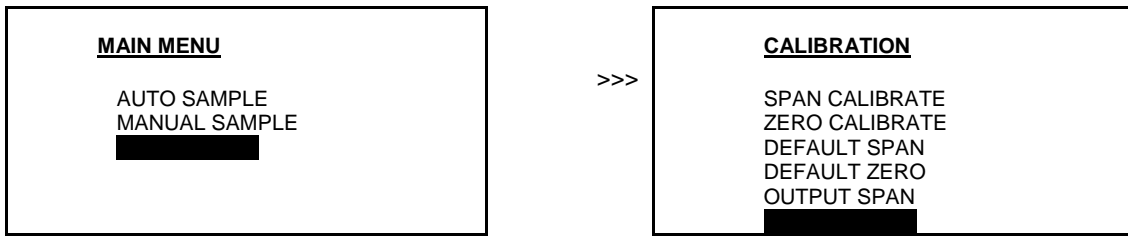

Advance the reverse shade cursor using the ARROW keys to highlight DEFAULT ZERO. Press the ENTER key to select the highlighted menu option. The following display appears:

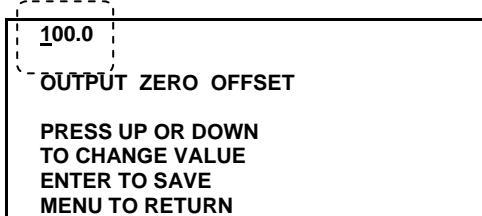

Enter the calculated adjustment value. **Note:** Once the initial adjustment is made and checked at the PLC it may be necessary to fine tune the initial adjustment by repeating. Any additional percent error must be added or subtracted from the initial adjustment value

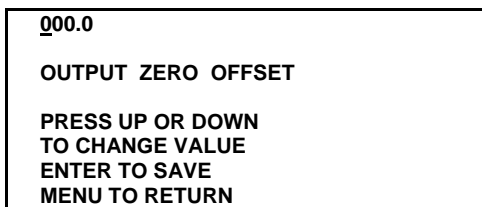

Press the ENTER key to advance the underline cursor right or press the MENU key to advance the underline cursor left to reach to the desired digit of the adjustment OUTPUT ZERO OFFSET value. Press the ARROW keys to enter each the numerical value of each digit of the adjustment OUTPUT ZERO OFFSET value. Repeat until the complete OUTPUT ZERO OFFSET value has been entered. Save the adjustment value by pressing the ENTER key or abort by pressing the MENU key. The system will then return to the SAMPLE mode.

Output Span

Access the MAIN MENU by pressing the MENU key. Advance the reverse shade cursor using the ARROW keys to highlight CALIBRATION. Press the ENTER key to select the highlighted menu option. The following displays appear:

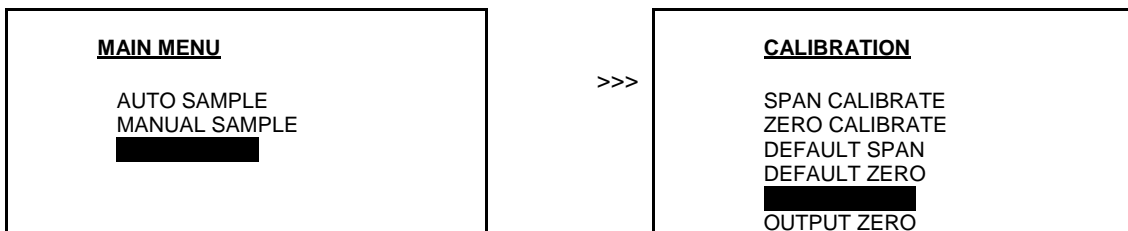

Advance the reverse shade cursor using the ARROW keys to highlight OUTPUT SPAN. Press the ENTER key to select the highlighted menu option.

The following display appears:

100.0
OUTPUT SPAN OFFSET
PRESS UP OR DOWN
TO CHANGE VALUE
ENTER TO SAVE
MENU TO RETURN

Enter the calculated adjustment value, refer to example described above. **Note:** Once the initial adjustment is made and checked at the PLC it may be necessary to fine tune the initial adjustment by repeating. Any additional percent error must be added or subtracted from the initial adjustment value

064.0
OUTPUT SPAN OFFSET
PRESS UP OR DOWN
TO CHANGE VALUE
ENTER TO SAVE
MENU TO RETURN

Press the ENTER key to advance the underline cursor right or press the MENU key to advance the underline cursor left to reach to the desired digit of the adjustment OUTPUT SPAN OFFSET value.
Press the ARROW keys to enter the numerical value of each digit of the OUTPUT SPAN OFFSET value.
Repeat until the complete OUTPUT SPAN OFFSET value has been entered.
Save the adjustment value by pressing the ENTER key or abort by pressing the MENU key. The system will then return to the SAMPLE mode

Appendix F

H₂S Scrubbers & Sample Systems



B-2734-6 1x6"
 B-2734 1.5x12"
 B-3247 2.5x6"



B-3251 H₂S Scrubber System



GPR-1500 AIS with
 B-3247 H₂S Scrubber
 A-3393 H₂S Scrubber System

Advanced Instruments Inc. offers a complete line of efficient hydrogen sulfide (H₂S) scrubbers and sample conditioning systems for:

- Preparing a gas stream containing H₂S for oxygen analysis
- Zero gas generation for H₂S transmitters

The scrubber media selectively removes H₂S and other oxidizing gases from the gas stream that can interfere with the oxygen measurement. As an indication the scrubber is nearing the end of its useful life the media changes color from purple to orange to brown to white as it is consumed.

The information included herein is based on data sheets published by the manufacturer of the scrubbing media as follow: the media not only adsorbs gases but also chemically transforms them into harmless end products that remain trapped in the media. Unlike adsorption, chemisorption is an instantaneous and irreversible process that permanently removes unwanted gases from the environment. The potassium permanganate (KMnO₄), the purple colored media inside the scrubber, turns into manganese oxide and elemental sulfur salt which are stable non-leachable solids.

Scrubbers are available in refillable:

- 1.0" x 6" (P/N B-2734-6) plexi-glass container with SS connections
- 1.5" x 12" (P/N B-2734) plexi-glass container with SS connections
- 2.0" x 24" (P/N A-2839) stainless steel container with SS connections
- 2.5" x 6" (P/N B-3247) plexi-glass container with SS connections
- 2.5" x 24" (P/N B-3247-24) plexi-glass container with SS connections

They can be installed in-line or as part of a complete scrubber sample conditioning system. More elaborate custom designed scrubber sample conditioning systems can include dual scrubbers and valve system that can eliminate downtime. Operators simply switch the gas flow to the fresh scrubber while servicing the other one.

Specifications:

Inlet connections: 1/4" SS tube fitting (refill port)
 Outlet connections: 1/4" SS tube fitting
 Pressure rating: 30 psig maximum
 Temperature: -20°C to 45°C (-4°F to 113°F)
 Application conditions: Free of moisture (may require coalescing filter)
 Materials of construction: Clear acrylic and/or stainless steel
 Scrubber life: Varies with flow rate, media volume, H₂S concentration

Dimensions Part No.	H ₂ S Concentration	Flow Rate	Service Life - Days
1.5" x 12" (P/N B-2734)	1.0% (10,000 ppm)	1/3 SCFH (150 sccm)	3.6
	0.1% (1,000 ppm)	same	36.8
	0.01% (100 ppm)	same	368.2
2.5" x 6" (P/N B-3247)	1.0% (10,000 ppm)	1/3 SCFH (150 sccm)	6.0
	0.1% (1,000 ppm)	same	59.6
	0.01% (100 ppm)	same	596.4

H₂S Sample System

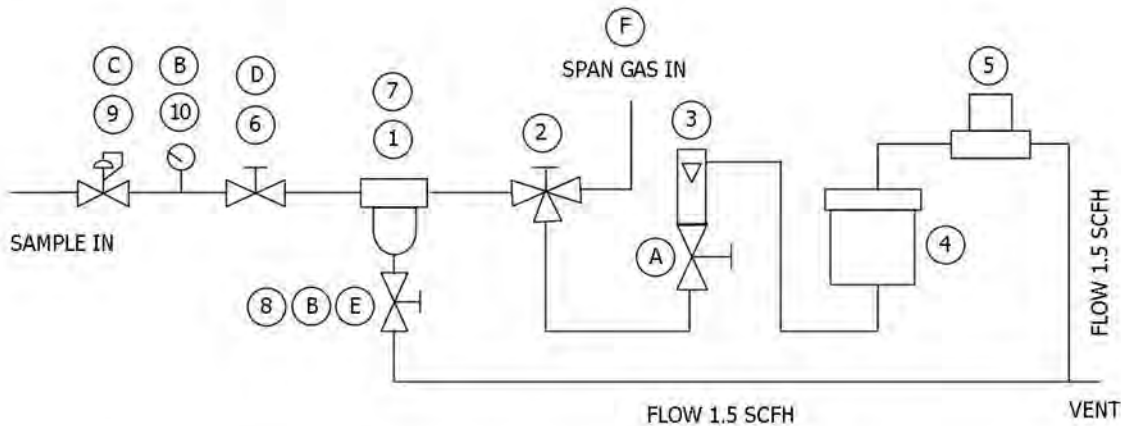

A-3393 STANDARD CONFIGURATION

- * B-3359 SAMPLE PANEL (NOT SHOWN)
- 1. FLTR-1002-2 FILTER COALESCING
- 2. VALV-1002 VALVE SS 3-WAY SAMPLE/SPAN
- 3. FMTR-1007-1 FLOW METER, INTEGRAL VALVE
- 4. B-3247-1 SCRUBBER H₂S CLEAR POLYCARB 2.5" ID
- 5. B-3310-A-18 SENSOR HOUSING ASSEMBLY SS
- * FITN-1016 3x BULKHEAD UNION 1/8" TO 1/4" SAMPLE, SPAN, VENT CONNECTIONS

A-3393-1 NO H₂S SCRUBBER OPTION:

- DELETE 4. B-3247-1 SCRUBBER H₂S CLEAR POLYCARB 2.5" ID

A-3393-2 CONTINUOUS DRAIN OPTION:

- ADD 6. VALV-1004 VALVE SS 2-WAY METERING
- REPLACE 7. FLTR-1024 FILTER COALESCING, FNPT DRAIN
- ADD 8. VALV-1033 VALVE PLASTIC 2-WAY DRAIN

A-3393-3 NO H₂S SCRUBBER WITH CONTINUOUS DRAIN OPTION:

- COMBINE OPTIONS 1 & 2

A-3393-4 PRESSURE REGULATOR & GAUGE OPTION:

- REPLACE B-3358 SAMPLE PANEL (REPLACES B-3359)
- ADD 9. REG-1013 PRESSURE REGULATOR SS
- ADD 10. REG-1008 GAUGE

A-3393-5 NO H₂S SCRUBBER WITH PRESSURE REGULATOR & GAUGE OPTION:

- COMBINE OPTIONS 1 & 4

A-3393-6 PRESSURE REGULATOR & GAUGE WITH CONTINUOUS DRAIN OPTION:

- COMBINE OPTIONS 4 & 2

A-3393-7 NO H₂S SCRUBBER WITH PRESSURE REGULATOR & GAUGE WITH CONTINUOUS DRAIN OPTION:

- COMBINE OPTIONS 1, 4 & 2

CONTINUOUS DRAIN SET-UP:

- A. OPEN VALVE
- B. CLOSE VALVE
- C. SET REGULATOR, 20-30 PSIG
- D. OPEN VALVE TO 3 SCFH ON FLOW METER
- E. OPEN VALVE TO 1.5 SCFH ON FLOW METER
- F. SET VALVE ON FLOW METER TO 2 SCFH FOR SPAN GAS, AFTER SPAN, OPEN VALVE FOR SAMPLE

2/7/07 REV 1 - CHANGE STANDARD CONFIGURATION, ADD OPTIONS

Advanced Instruments Inc.

THIS DRAWING IS THE PROPERTY OF ADVANCED INSTRUMENTS INC. AND CONTAINS CONFIDENTIAL INFORMATION. IT IS TO BE REPRODUCED OR USED IN ANY MANNER WITHOUT WRITTEN PERMISSION.

TOLERANCES UNLESS OTHERWISE SPECIFIED: FRACTION 1/16", DECIMAL .005", ANGULAR .1/2

DATE 2/7/07 SCALE NONE DRAFTER BJB ENGINEER APPROVAL PSK REV LEVEL

MATERIAL ITEM NO. DESCRIPTION SEE LIST

DESCRIPTION: DRAWING NO.

GPR-1500 AIS/IS SAMPLE SYSTEM A-3393

Solubility in water

Insoluble

Appearance and Odor

Purple Spheres, No Odor

Section IV - Fire and Explosion Hazard Data

Flash Point (Method Used)	Not Flammable	Flammable Limits	None	LEL	N/A	UEL	N/A
---------------------------	---------------	------------------	------	-----	-----	-----	-----

Extinguishing Media

Foam, Carbon Dioxide, or Dry Chemical

38

Special Fire Fighting Procedures

Use Respiratory Protection

Unusual Fire and Explosion Hazards

None

Appendix G

Maintenance – H₂S Scrubber

Servicing any of the H₂S scrubbers will depend on several factors as illustrated in Appendix F and include: the (average) H₂S concentration (average), volume of scrubber media and flow rate through the scrubber (often times maximizing the service life means longer system response time) see Appendix F.

Required equipment:

1. 2x 7/16" open end wrenches
2. 1x 9/16" open end wrench
3. 1x 1" open end or adjustable wrench

Procedure:

Separate the top connection to the scrubber using a 7/16" and the 9/16" open end wrenches on the two top nuts. Hold the second nut with the 9/16" open end wrench.

With one of the 7/16" open end wrenches turn the top nut counter clockwise until the fitting disengages.

Separate the bottom connection to the scrubber using both 7/16" open end wrenches.

Hold the nut at the bottom of the scrubber with a 7/16" open end wrench.

With the other 7/16" open end wrench turn the nut below counter clockwise until the fitting disengages.

Carefully, do not loose the ferrules inside the fitting, remove the stainless tubing from the top and bottom of the scrubber.

Carefully pull the scrubber from its mounting clip which is attached to the back panel.

Once the scrubber is free, hold the scrubber with one hand and using the 1" open end or adjustable wrench with the other hand, turn the 1" nut counter clockwise and remove the 1" nut at the top of the scrubber.

There is no need to remove the 7/16" fitting at the bottom of the scrubber.

With the 1" nut removed, empty the spent media through the opening.

Fill the scrubber with fresh media (should be rich purple in color).

Reverse the above steps to re-assemble and install the scrubber.

Maintenance – Coalescing Filter

Servicing the coalescing filter (P/N FLTR-1002-2) depends on the cleanliness and moisture content of the sample and maintenance intervals.

Required equipment:

Channel locks

Damp rag

Lubricant (a thin coat applied to the o-ring after cleaning helps ensure a tight seal and extend o-ring life)

Procedure:

Unscrew the clear polycarbonate bowl by turning it counter clockwise.

Note: It is probably stuck tight – use the damp rag to grip if removing by hand or to prevent damage to the bowl if using the channel locks.

The bowl seals to the head section with an o-ring, do not lose the o-ring.

The filter element screws into the head section, carefully turn it counter clockwise and remove.

Using the damp cloth, clean the inside of the bowl and the o-ring before reassembling – apply a very thin coat of lubricant to the o-ring.

Reverse the above steps to re-assemble the filter.